

# Double Wave Modulation Unit

Operation manual



Recog	Colla	Creat
Umemoto	Umemoto	Miyazaki
'08/06/09	'08/06/09	'08/06/09



NICOS CORPORATION

**Revision history**

R1.0.0	2008/06/09	Miyazaki	New production
R1.1.0	2009/03/03	Miyazaki	Modified the explanations for an input-output circuit and division ratio settings.
R1.2.0	2009/06/10	Miyazaki	Modified the explanation for the time-chart.
R1.3.0	2010/04/14	Miyazaki	Addition of explanation of change of division-ratio.
R1.4.0	2010/06/01	Miyazaki	Change of open collector output ratings current value.

## □□□ CONTENTS □□□

1. INTRODUCTION .....	4
2. FUNCTIONAL DESCRIPTION .....	4
3. SPECIFICATION .....	5
4. THE NAME OF EACH PART, AND SETTING OUT .....	7
4.1. MAIN PANEL .....	7
4.2. OPERATIONAL MODE SETTINGS .....	18
4.2.1. (Single Phase Pulse 1 Input) setting list .....	19
4.2.2. (Single Phase Pulse 2 Input) setting list .....	20
4.2.3. (two phase Pulse Input) setting list .....	21
4.2.4. (Single Phase Pulse + Direction-Signals Input) setting list .....	23
4.2.5. (CW/CCW Input) setting list .....	25
4.3. BLOCK DIAGRAM .....	28
5. INPUT OUTPUT CIRCUIT .....	29
5.0. CONNECTION CONVERSION TABLE .....	29
5.1. CURRENT DRIVE INPUT CIRCUIT BY PHOTO COUPLER INSULATION .....	30
5.2. LINE RECEIVER INPUT CIRCUIT .....	31
5.3. OPEN COLLECTOR OUTPUT CIRCUIT BY PHOTO COUPLER INSULATION .....	32
5.4. LINE DRIVER OUTPUT CIRCUIT .....	33
5.5. REMOTE INPUT CIRCUIT .....	34
6. OUTLINE DRAWING .....	35
7. TIMING CHART .....	36

## 1. Introduction

This book is an operation manual of a Double Wave Modulation Unit (DWMU-0002A).

Double Wave Modulation Unit is dividing and distributing an input pulse (single phase, two phases, direction-discriminating-signal + single phase, CW, CCW).

## 2. Functional Description

### 2.1. Dividing Function

- With settings of this unit, input pulse is divided into 1 to 255. (For example: If the input frequency is 10 kHz and the setting value is 5, then the output frequency becomes 2 kHz.)
- Setting of division ratio can be set as independent division ratio against two outputs (CH1, CH2) respectively.
- Setting of division ratio is performed with rotary DIP switch. And with those setting values,
  - 1/1 - 1 / 255 (Setting of all range is possible),
  - 2/1 - 1 / 127 (Setting of all range is possible),
  - 1/2 - 1 / 510 (only setting of 1/(1 to 255x2) is possible),
  - 1/4 - 1 / 1020 (only setting of 1/(1 to 255x4) is possible),
 setting can be made.

### 2.2. Waveform-Generations Function

- Perform the waveform generations of the single-phase input pulse to two phases (A phase, B phase), and output it.
- Waveform generations can be independently performed to CH1 and CH2, respectively.

### 2.3. Distribution Function

- Output the same pulse to a separate output terminal.
- For a distributing, two distribution can be performed for a 'single phase pulse with a direction-discriminating-signal' output and a 'two phase pulse' output, and maximum of 4 distribution can be performed for a 'single phase pulse' output.

The input/output pulse can be performed with the following settings.

Input	Output
Single phase pulse	Single phase pulse
	two phase pulse
two phase pulse	Single phase pulse
	two phase pulse
	A single phase pulse with a direction-discriminating-signal
	CW-CCW pulse
A single phase pulse with a direction-discriminating-signal	Single phase pulse
	two phase pulse
	A single phase pulse with a direction-discriminating-signal
	CW-CCW pulse
CW-CCW pulse	Single phase pulse
	two phase pulse
	A single phase pulse with a direction-discriminating-signal
	CW-CCW pulse

### 3. Specification

#### ■ Power source

Form	DWMU-002A
Power specifications	DC24V (1.5A) $\pm$ 10%

\* Power feeding, such as a rotary encoder, is included.

#### ■ External interface

(Pulse input part)

Input form *1, *4	(1)	Current drive input by photo coupler insulation (a maximum of 30 m) *2
	(2)	Line receiver input (100 m of maximum cable length) *2
Input resistor	About 770 $\Omega$	
Maximum input frequency	50 kHz (100 kHz: in the case of a line receiver)	

\*1 Choose input form (1) or (2).

\*2 However, it is based on wiring environment.

(Pulse output part) \*4

Output form *4	(1)	Open collector output by photo coupler insulation (a maximum of 30 m) *2
	(2)	Line driver output (100 m of maximum cable length) *2
Maximum output rating	DC35V 50mA	
Maximum output frequency	50kHz (100 kHz: in case of line driver) *3	

\*2 However, it is based on wiring environment.

\*3 An output pulse has the delay of about 1microSec to an input pulse.

\*4 In use other than a single phase pulse input/output, an error may come out depending on a manner of use.

(Remote input part)

Input voltage	24V
Input current	10mA
Input resistor	2.4K $\Omega$

#### ■ Service condition

Peripheral temperature	0~45 $^{\circ}$ C
Circumference humidity	20 to 90%RH (there needs to be no dew condensation)
Peripheral atmosphere	There are not combustibility and corrosive gas and dust is not severe.

## ■ Storage conditions

Peripheral temperature	-15 ~ 80 °C
Circumference humidity	20 to 90%RH (there needs to be no dew condensation)
Peripheral atmosphere	There are not combustibility and corrosive gas and dust is not severe.

## ■ Outside-diameter weight

Outside diameter size	160 (W) × 90 (H) × 58 (D) mm
Weight	About 300 g
The cooling method	Self-cooling

4. The name of each part, and setting out

4.1. Main panel

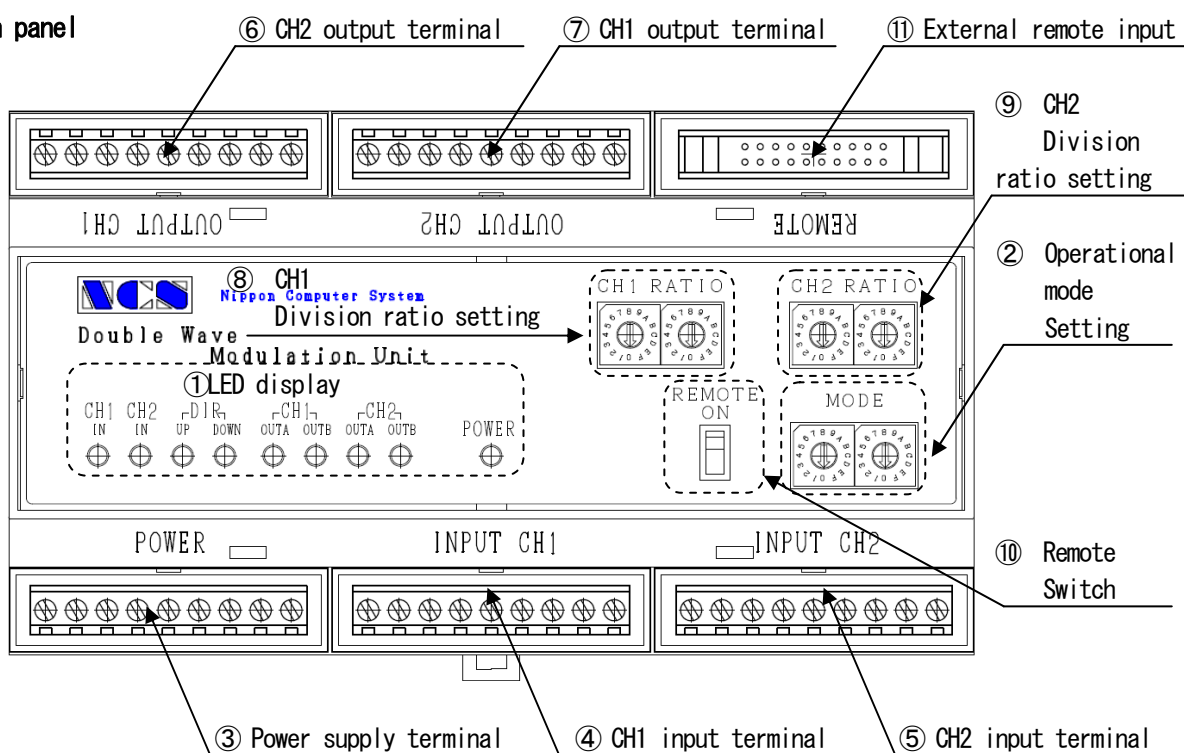

① LED display

Each output pulse, and signal state of a two phase pulse input and a direction-discriminating-signal input are displayed.

CH1	IN	The input signal state of CH1 input terminal is displayed.
	OUT A	The output signal status of CH1 input terminal (OUT A) is displayed.
	OUT B	The output signal status of CH1 input terminal (OUT B) is displayed.
CH2	IN	The input signal state of CH2 input terminal is displayed.
	OUT A	The output signal status of CH2 input terminal (OUT A) is displayed.
	OUT B	The output signal status of CH2 input terminal (OUT B) is displayed.
UP/DOWN		According to a direction, either UP or DOWN lights up at the time of a CW-CCW pulse input or a direction-discriminating-signal input or at the time of a two phase pulse input.

\* A LED lamp lights up at the time of ON of an input signal, or ON of output.

② Operational mode setting

It is a rotary switch for setting up a various function. Refer to the 12-page operational mode setting out for the method of setting out.

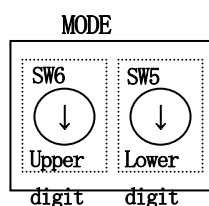

(Figure 2 operational-mode setting switch)



③ Power input terminal (Fig. 1 power input terminal)

It is a terminal which supplies a power source to an Double Wave Modulation Unit.

Terminal numbers	Terminal name	Terminal explanation
1	+24V	+24V (DC) of a supplied power source
2	0V	The ground of a supplied power source (0V)
3	FG	Frame ground (grounding)
4	-	-
5	-	-
6	-	-
7	-	-
8	+24V OUT	For rotary encoders
9	+24V OUT	+24V (DC) power supply terminal. MAX500mA

A blank (-) is a vacant terminal. Please do not make connection.

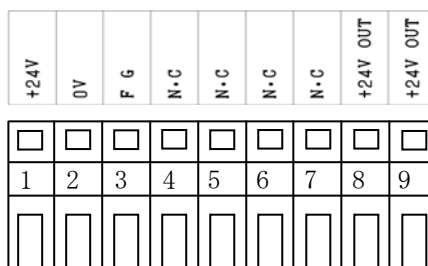

(Fig. 1 Power input terminal)

④ CH1 input terminal (figure 2 CH1 input terminal)

It is a terminal linked to pulse output instruments, such as a rotary encoder.

Terminal numbers	Terminal name	Terminal explanation								
1	+12V OUT	For rotary encoders +12V(DC) Power supply terminal. MAX500mA								
2	SIG A	The input signal contact button for open collectors								
		<table border="1"> <thead> <tr> <th>Input pulse</th> <th>Connection explanation</th> </tr> </thead> <tbody> <tr> <td>two phase pulse</td> <td>The A phase side is connected.</td> </tr> <tr> <td>A single phase pulse with a direction-discriminating-signal</td> <td>The single phase side is connected.</td> </tr> <tr> <td>CW-CCW pulse</td> <td>The CW pulse side is connected.</td> </tr> </tbody> </table>	Input pulse	Connection explanation	two phase pulse	The A phase side is connected.	A single phase pulse with a direction-discriminating-signal	The single phase side is connected.	CW-CCW pulse	The CW pulse side is connected.
		Input pulse	Connection explanation							
		two phase pulse	The A phase side is connected.							
A single phase pulse with a direction-discriminating-signal	The single phase side is connected.									
CW-CCW pulse	The CW pulse side is connected.									
3	+5V OUT	For rotary encoders +5V(DC) power supply terminal. MAX500mA								
4	SIG A+	The input signal terminal (+) for line receivers								
5	SIG A-	The input signal terminal (-) for line receivers								
6	GND	The ground terminal of an input signal (Power-source ground for rotary encoders)								
7	TR +	Line receiver termination register terminal (+)								
8	TR -	Line receiver termination register terminal (-)								
9	FG	The shield connection terminal of a signal cable								

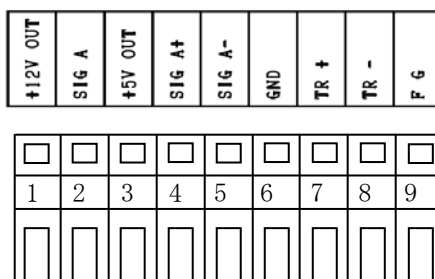

(Figure 2 CH1 input terminal)

⑤ CH2 input terminal (figure 3 CH2 input terminal)

It is a terminal linked to pulse output instruments, such as a rotary encoder.

Terminal numbers	Terminal name	Terminal explanation								
1	+12V OUT	For rotary encoders +12V(DC) power supply terminal. MAX500mA								
2	SIG B	The input signal contact button for open collectors								
		<table border="1"> <thead> <tr> <th>Input pulse</th> <th>Connection explanation</th> </tr> </thead> <tbody> <tr> <td>two phase pulse</td> <td>The B phase side is connected.</td> </tr> <tr> <td>A single phase pulse with a direction-discriminating-signal</td> <td>The direction-discriminating-signal side is connected.</td> </tr> <tr> <td>CW-CCW pulse</td> <td>The CCW pulse side is connected.</td> </tr> </tbody> </table>	Input pulse	Connection explanation	two phase pulse	The B phase side is connected.	A single phase pulse with a direction-discriminating-signal	The direction-discriminating-signal side is connected.	CW-CCW pulse	The CCW pulse side is connected.
		Input pulse	Connection explanation							
two phase pulse	The B phase side is connected.									
A single phase pulse with a direction-discriminating-signal	The direction-discriminating-signal side is connected.									
CW-CCW pulse	The CCW pulse side is connected.									
3	+5V OUT	For rotary encoders +5V(DC) power supply terminal. MAX500mA								
4	SIG B+	The input signal terminal (+) for line receivers								
5	SIG B-	The input signal terminal (-) for line receivers								
6	GND	The ground terminal of an input signal (Power-source ground for rotary encoders)								
7	TR +	Line receiver termination register terminal (+)								
8	TR -	Line receiver termination register terminal (-)								
9	FG	The shield connection terminal of a signal cable								

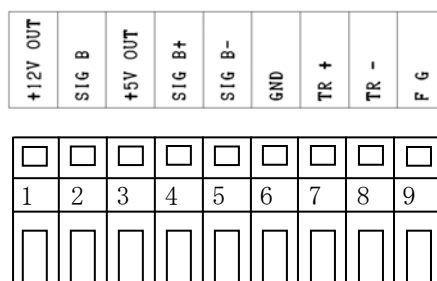

(Figure 3 CH2 input terminal)

⑥ CH1 output terminal (figure 4 CH1 output terminal)

It is a pulse output terminal.

Terminal numbers	Terminal name	Terminal explanation
1	OUT A	The output signal terminal for open collectors
2	OUT A+	The output signal terminal (+) for line drivers
3	OUT A-	The output signal terminal (-) for line drivers
4	COM	The ground (OV) terminal of output
5	OUT B	The output signal terminal for open collectors
6	OUT B+	The output signal terminal (+) for line drivers
7	OUT B-	The output signal terminal (-) for line drivers
8	COM	The ground (OV) terminal of output
9	FG	The shield connection terminal of a signal cable

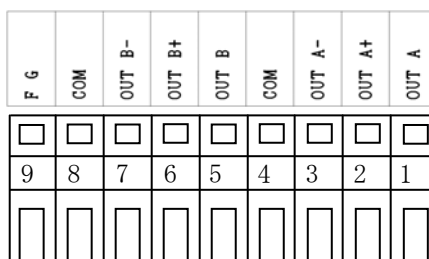

(Figure 4 CH1 output terminal)

⑦ CH2 output terminal (figure 5 CH2 output terminal)

It is a pulse output terminal.

Terminal numbers	Terminal name	Terminal explanation
1	OUT A	The output signal terminal for open collectors
2	OUT A+	The output signal terminal (+) for line drivers
3	OUT A-	The output signal terminal (-) for line drivers
4	COM	The ground (0V) terminal of output
5	OUT B	The output signal terminal for open collectors
6	OUT B+	The output signal terminal (+) for line drivers
7	OUT B-	The output signal terminal (-) for line drivers
8	COM	The ground (0V) terminal of output
9	FG	The shield connection terminal of a signal cable

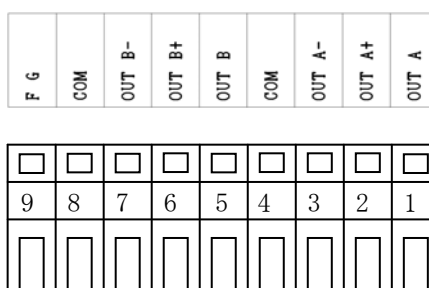

(Figure 5 CH2 output terminal)

- ⑧ CH1 dividing setting (figure 6 CH1 division-ratio configuration switch)
- ⑨ CH2 dividing setting (figure 7 CH2 division-ratio configuration switch)

These are switches for setting up the division ratio for each of CH1 and CH2.

A division ratio is set up by setting of these switches.

The division ratio of CH1 sets up by RSW1 and RSW2,  
and the division ratio of CH2 sets up by RSW3 and RSW4.

※Please change the division-ratio in power supply off.

(With a operational mode setting, there might be the same division ratio to CH1 and CH2,  
by the setting up of the division ratio of RSW1 and RSW2.)

A division ratio is set up in two figures hexadecimals (HEX).

Therefore, the range of a division ratio serves as 1/1-1/FF (it is 1 / 1 - 1/255 by a decimal numeral).

However, please do not set division ratio setting out as "00 (HEX)." A division ratio becomes unfixed.

- When division ratio ranges are (1 / 2 - 1/510) in operational mode setting out, it becomes by 1/2 time the set-up division ratio.
- When division ratio ranges are (1 / 4 - 1/1020) in operational mode setting out, it will be 1/4 time the set-up division ratio.

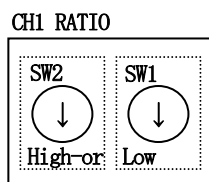

(Figure 6 CH1 division-ratio configuration switch)

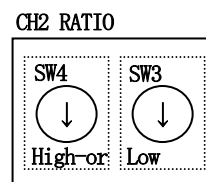

(Figure 7 CH2 division-ratio configuration switch)

---

■ The example of division ratio setting out

(Example 1)

When setting of a division ratio is set to "05",  
it means as "05 (HEX) = 05 (DEC) ",  
and the division ratio is set to one fifth.

(Example 2)

When setting of a division ratio is set to "FF"  
it means as "FF (HEX) = 255 (DEC) ",  
and the division ratio will be 1/255.

(Example 3)

When the division ratio range is "1/2 - 1/510" in operational mode setting,  
if the division ratio is set to "05",  
it means "1/5 x 1/2 = 1/10",  
and the division ratio will be 1/10.

(Example 4)

When the division ratio range is "1/4 - 1/1020" in operational mode setting,  
if the division ratio is set to "06",  
it means "1/6 x 1/4 = 1/24",  
and the division ratio will be 1/12.

(Example 5)

When the division ratio range is "2/1 - 1/127" in operational mode setting,  
if the division ratio is set to "04",  
it means "2 x 1/4 = 1/2",  
and the division ratio is set to one half.

⑩ Remote switch (Fig. 8 remote switch)

It is a switch to change the setting origin (internal switch setting / external remote setting) of the division ratio.

State	Setting origin of a division ratio
REMOTE ON	External remote setting
REMOTE OFF	Internal switch setting

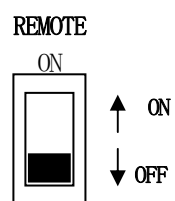

(Fig. 8 Remote switch)



⑪ External remote input (Fig. 9 external remote connector)

At the time of a remote input, it is a connector which inputs a signal.

- Use A1-A8 to set division ratio setting for CH1.
- Use B1-B8 to set division ratio setting for CH2.

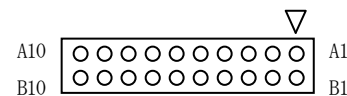

Fig. 9 External remote connector (MIL connector 20P)

A connector pin number and a terminal name are shown in below table.

Pin number	Signal name	Pin number	Signal name
A1	1-2 <sup>0</sup>	B1	3-2 <sup>0</sup>
A2	1-2 <sup>1</sup>	B2	3-2 <sup>1</sup>
A3	1-2 <sup>2</sup>	B3	3-2 <sup>2</sup>
A4	1-2 <sup>3</sup>	B4	3-2 <sup>3</sup>
A5	2-2 <sup>0</sup>	B5	4-2 <sup>0</sup>
A6	2-2 <sup>1</sup>	B6	4-2 <sup>1</sup>
A7	2-2 <sup>2</sup>	B7	4-2 <sup>2</sup>
A8	2-2 <sup>3</sup>	B8	4-2 <sup>3</sup>
A9	Pulse output stop 1	B9	Pulse output stop 2
A10	COM	B10	COM

Please set up the division ratio in the binary digit (BIN) corresponding to the below table.

Terminal numbers	A8	A7	A6	A5	A4	A3	A2	A1
	B8	B7	B6	B5	B4	B3	B2	B1
Setting item	High-order digit				Low-order digit			
Binary digit value (BIN)	2 <sup>3</sup>	2 <sup>2</sup>	2 <sup>1</sup>	2 <sup>0</sup>	2 <sup>3</sup>	2 <sup>2</sup>	2 <sup>1</sup>	2 <sup>0</sup>

A pulse is not outputted while having inputted the signal into the “pulse output stop”. When you change a division ratio, please change, while having inputted the signal into the “pulse output stop”. However, please do not set division ratio setting out as “00 (HEX).” A division ratio becomes unfixed.

(Example 1)

A8	A7	A6	A5	A4	A3	A2	A1
0	0	0	0	0	1	0	1

When setting a division ratio as  
it means “00000101 (BIN) = 05 (HEX) = 05 (DEC)”

and the division ratio is set to one fifth.

(Example 2)

A8	A7	A6	A5	A4	A3	A2	A1
1	1	1	1	1	1	1	1

When setting a division ratio as  
it means “11111111 (BIN) = FF (HEX) = 255 (DEC)”

and the division ratio will be 1/255.

### 4.2. Operational mode settings

Operational mode setting is set up by SW5 and SW6.  
Operational mode is set up in 2 figures hexadecimal (HEX).

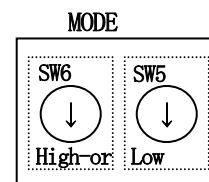

Please carry out the setting variation of operational mode is  
[ the power source of the Double Wave Modulation Unit ] in the state of OFF.

An operational mode table is shown from the following page.  
The view of an operational mode table is explained below.

Set point — Set point of an operational mode configuration switch  
 Open collector — In the case of the current drive input by photo coupler insulation  
 Line receiver — In the case of a line receiver input  
 SW6 — Value of the rotary DIP switch of SW6  
 SW5 — Value of the rotary DIP switch of SW5

Division ratio Range which can be set

The kind of output pulse is displayed.

The kind of input pulse is displayed.

Labeling of CH

Set point				CH	Input Pulse	Output Pulse	Division ratio setting Possible range
Open collector		Line receiver					
SW6	SW5	SW6	SW5				
0	0	8	0	CH1	S	A1/B1	(1 / 4 - 1/1020)
				CH2	-	A2/B2	(1 / 4 - 1/1020)
0	1	8	1	CH1	S	A1/B1	(1 / 2 - 1/510)
				CH2	-	A2/B2	(1 / 2 - 1/510)

■ Sign explanation of an input/output pulse

The kind of pulse over the alphabet becomes as follows.

- S — Single phase pulse input
- C — Direction-discriminating-signal
- A — A phase pulse input
- B — B phase pulse input
- CW — CW pulse input
- CCW — CCW pulse input

■ Explanation of the numerical value which is beside the alphabet of an output pulse

CH which performs division ratio setting is expressed.

- S1, A1, B1, CW1, CCW1 — It outputs with CH1 division-ratio configuration switch.
- S2, A2, B2, CW2, CCW2 — It outputs with CH2 division-ratio configuration switch.

- Standard factory settings

When there are no directions of a manner of use at the time of an order, it is the following setting.

- SW1 — 1 and SW2 — 0 and SW3 — 1 and SW4 — 0,
- SW5 — 0 and SW6 — 2,
- Settings for    is performed as standard factory settings.

4.2.1. (Single Phase Pulse 1 Input) setting list

Set point				CH	Input Pulse	Output Pulse	Division ratio setting Possible range
Open collector		Line receiver					
SW6	SW5	SW6	SW5				
0	0	8	0	CH1	S	A1/B1	(1 / 4 - 1/1020)
				CH2	-	A2/B2	(1 / 4 - 1/1020)
0	1	8	1	CH1	S	A1/B1	(1 / 2 - 1/510)
				CH2	-	A2/B2	(1 / 2 - 1/510)
0	2	8	2	CH1	S	A1/B1	(1 / 4 - 1/1020)
				CH2	-	S2/S2	(1 / 2 - 1/510)
0	3	8	3	CH1	S	A1/B1	(1 / 2 - 1/510)
				CH2	-	S2/S2	(1 / 1 - 1/255)
0	4	8	4	CH1	S	S1/S1	(1 / 2 - 1/510)
				CH2	-	A2/B2	(1 / 4 - 1/1020)
0	5	8	5	CH1	S	S1/S1	(1 / 1 - 1/255)
				CH2	-	A2/B2	(1 / 2 - 1/510)
0	6	8	6	CH1	S	S1/S1	(1 / 2 - 1/510)
				CH2	-	S2/S2	(1 / 2 - 1/510)
0	7	8	7	CH1	S	S1/S1	(1 / 1 - 1/255)
				CH2	-	S2/S2	(1 / 1 - 1/255)
0	8	8	8	CH1	S	A1/B1	(1 / 4 - 1/1020)
				CH2	-	A1/B1	(1 / 4 - 1/1020)
0	9	8	9	CH1	S	A1/B1	(1 / 2 - 1/510)
				CH2	-	A1/B1	(1 / 2 - 1/510)
0	A	8	A	CH1	S	A1/B1	(1 / 4 - 1/1020)
				CH2	-	S1/S1	(1 / 2 - 1/510)
0	B	8	B	CH1	S	A1/B1	(1 / 2 - 1/510)
				CH2	-	S1/S1	(1 / 1 - 1/255)
0	C	8	C	CH1	S	S1/S1	(1 / 2 - 1/510)
				CH2	-	A1/B1	(1 / 4 - 1/1020)
0	D	8	D	CH1	S	S1/S1	(1 / 1 - 1/255)
				CH2	-	A1/B1	(1 / 2 - 1/510)
0	E	8	E	CH1	S	S1/S1	(1 / 2 - 1/510)
				CH2	-	S1/S1	(1 / 2 - 1/510)
0	F	8	F	CH1	S	S1/S1	(1 / 1 - 1/255)
				CH2	-	S1/S1	(1 / 1 - 1/255)

A blank (-) is an undefined. An input and an output are unfixed.

- Explanation of the numerical value which is beside the alphabet of an output pulse CH which performs division ratio setting is expressed.

S\* “\*=1” means that CH1 division-ratio configuration switch, and is dividing.  
 “\*=2” means that CH2 division-ratio configuration switch, and is dividing.

## 4.2.2. (Single Phase Pulse 2 Input) setting list

Set point				CH	Input Pulse	Output Pulse	Division ratio setting Possible range
Open collector		Line receiver					
SW6	SW5	SW6	SW5				
1	0	9	0	CH1	S	A1/B1	(1 / 4 - 1/1020)
				CH2	S	A2/B2	(1 / 4 - 1/1020)
1	1	9	1	CH1	S	A1/B1	(1 / 2 - 1/510)
				CH2	S	A2/B2	(1 / 2 - 1/510)
1	2	9	2	CH1	S	A1/B1	(1 / 4 - 1/1020)
				CH2	S	S2/S2	(1 / 2 - 1/510)
1	3	9	3	CH1	S	A1/B1	(1 / 2 - 1/510)
				CH2	S	S2/S2	(1 / 1 - 1/255)
1	4	9	4	CH1	S	S1/S1	(1 / 2 - 1/510)
				CH2	S	A2/B2	(1 / 4 - 1/1020)
1	5	9	5	CH1	S	S1/S1	(1 / 1 - 1/255)
				CH2	S	A2/B2	(1 / 2 - 1/510)
1	6	9	6	CH1	S	S1/S1	(1 / 2 - 1/510)
				CH2	S	S2/S2	(1 / 2 - 1/510)
1	7	9	7	CH1	S	S1/S1	(1 / 1 - 1/255)
				CH2	S	S2/S2	(1 / 1 - 1/255)
1	8	9	8	CH1	-	-	-
				CH2	-	-	-
1	9	9	9	CH1	-	-	-
				CH2	-	-	-
1	A	9	A	CH1	-	-	-
				CH2	-	-	-
1	B	9	B	CH1	-	-	-
				CH2	-	-	-
1	C	9	C	CH1	-	-	-
				CH2	-	-	-
1	D	9	D	CH1	-	-	-
				CH2	-	-	-
1	E	9	E	CH1	-	-	-
				CH2	-	-	-
1	F	9	F	CH1	-	-	-
				CH2	-	-	-

A blank (-) is an undefined. An input and an output are unfixed.

## 4.2.3. (two phase Pulse Input) setting list

Set point				CH	Input Pulse	Output Pulse	Division ratio setting Possible range
Open collector		Line receiver					
SW6	SW5	SW6	SW5				
2	0	A	0	CH1	A	A1/B1	(1 / 2 - 1/510)
				CH2	B	A2/B2	(1 / 2 - 1/510)
2	1	A	1	CH1	A	A1/B1	(1 / 1 - 1/255)
				CH2	B	A2/B2	(1 / 1 - 1/255)
2	2	A	2	CH1	A	A1/B1	(1 / 2 - 1/510)
				CH2	B	S2/S2	(1 / 1 - 1/255)
2	3	A	3	CH1	A	A1/B1	(1 / 1 - 1/255)
				CH2	B	S2/S2	(2 / 1 - 1/127)
2	4	A	4	CH1	A	S1/S1	(1 / 1 - 1/255)
				CH2	B	A2/B2	(1 / 2 - 1/510)
2	5	A	5	CH1	A	S1/S1	(2 / 1 - 1/127)
				CH2	B	A2/B2	(1 / 1 - 1/255)
2	6	A	6	CH1	A	S1/S1	(1 / 1 - 1/255)
				CH2	B	S2/S2	(1 / 1 - 1/255)
2	7	A	7	CH1	A	S1/S1	(2 / 1 - 1/127)
				CH2	B	S2/S2	(2 / 1 - 1/127)
2	8	A	8	CH1	A	A1/B1	(1 / 2 - 1/510)
				CH2	B	A1/B1	(1 / 2 - 1/510)
2	9	A	9	CH1	A	A1/B1	(1 / 1 - 1/255)
				CH2	B	A1/B1	(1 / 1 - 1/255)
2	A	A	A	CH1	A	A1/B1	(1 / 2 - 1/510)
				CH2	B	S1/S1	(1 / 1 - 1/255)
2	B	A	B	CH1	A	A1/B1	(1 / 1 - 1/255)
				CH2	B	S1/S1	(2 / 1 - 1/127)
2	C	A	C	CH1	A	S1/S1	(1 / 1 - 1/255)
				CH2	B	A1/B1	(1 / 2 - 1/510)
2	D	A	D	CH1	A	S1/S1	(2 / 1 - 1/127)
				CH2	B	A1/B1	(1 / 1 - 1/255)
2	E	A	E	CH1	A	S1/S1	(1 / 1 - 1/255)
				CH2	B	S1/S1	(1 / 1 - 1/255)
2	F	A	F	CH1	A	S1/S1	(2 / 1 - 1/127)
				CH2	B	S1/S1	(2 / 1 - 1/127)

A blank (-) is an undefined. An input and an output are unfixed.

- Standard factory settings

When there are no directions of a manner of use at the time of an order, it is the following setting.

SW1 — 1 and SW2 — 0 and SW3 — 1 and SW4 — 0,

SW5 — 0 and SW6 — 2,

Settings for  is performed as standard factory settings.

Set point				CH	Input Pulse	Output Pulse	Division ratio setting Possible range
Open collector		Line receiver					
SW6	SW5	SW6	SW5				
3	0	B	0	CH1	A	S1/C1	(1 / 1 - 1/255)
				CH2	B	S2/C2	(1 / 1 - 1/255)
3	1	B	1	CH1	A	S1/C1	(2 / 1 - 1/127)
				CH2	B	S2/C2	(2 / 1 - 1/127)
3	2	B	2	CH1	A	A1/B1	(1 / 2 - 1/510)
				CH2	B	S2/C2	(1 / 1 - 1/255)
3	3	B	3	CH1	A	A1/B1	(1 / 1 - 1/255)
				CH2	B	S2/C2	(2 / 1 - 1/127)
3	4	B	4	CH1	A	S1/C1	(1 / 1 - 1/255)
				CH2	B	A2/B2	(1 / 2 - 1/510)
3	5	B	5	CH1	A	S1/C1	(2 / 1 - 1/127)
				CH2	B	A2/B2	(1 / 1 - 1/255)
3	6	B	6	CH1	A	S1/C1	(1 / 1 - 1/255)
				CH2	B	S2/C2	(1 / 1 - 1/255)
3	7	B	7	CH1	A	S1/C1	(2 / 1 - 1/127)
				CH2	B	S2/C2	(2 / 1 - 1/127)
3	8	B	8	CH1	A	CW1/CCW1	(1 / 1 - 1/255)
				CH2	B	S2/C2	(1 / 1 - 1/255)
3	9	B	9	CH1	A	CW1/CCW1	(2 / 1 - 1/127)
				CH2	B	S2/C2	(2 / 1 - 1/127)
3	A	B	A	CH1	A	S1/C1	(1 / 1 - 1/255)
				CH2	B	CW2/CCW2	(1 / 1 - 1/255)
3	B	B	B	CH1	A	S1/C1	(2 / 1 - 1/127)
				CH2	B	CW2/CCW2	(2 / 1 - 1/127)
3	C	B	C	CH1	A	CW1/CCW1	(1 / 1 - 1/255)
				CH2	B	CW2/CCW2	(1 / 1 - 1/255)
3	D	B	D	CH1	A	CW1/CCW1	(2 / 1 - 1/127)
				CH2	B	CW2/CCW2	(2 / 1 - 1/127)
3	E	B	E	CH1	-	-	-
				CH2	-	-	-
3	F	B	F	CH1	-	-	-
				CH2	-	-	-

A blank (-) is an undefined. An input and an output are unfixed.

## 4.2.4. (Single Phase Pulse + Direction-Signals Input) setting list

Set point				CH	Input Pulse	Output Pulse	Division ratio setting Possible range
Open collector		Line receiver					
SW6	SW5	SW6	SW5				
4	0	C	0	CH1	S	A1/B1	(1 / 4 - 1/1020)
				CH2	C	A2/B2	(1 / 4 - 1/1020)
4	1	C	1	CH1	S	A1/B1	(1 / 2 - 1/510)
				CH2	C	A2/B2	(1 / 2 - 1/510)
4	2	C	2	CH1	S	A1/B1	(1 / 4 - 1/1020)
				CH2	C	S2/S2	(1 / 2 - 1/510)
4	3	C	3	CH1	S	A1/B1	(1 / 2 - 1/510)
				CH2	C	S2/S2	(1 / 1 - 1/255)
4	4	C	4	CH1	S	S1/S1	(1 / 2 - 1/510)
				CH2	C	A2/B2	(1 / 4 - 1/1020)
4	5	C	5	CH1	S	S1/S1	(1 / 1 - 1/255)
				CH2	C	A2/B2	(1 / 2 - 1/510)
4	6	C	6	CH1	S	S1/S1	(1 / 2 - 1/510)
				CH2	C	S2/S2	(1 / 2 - 1/510)
4	7	C	7	CH1	S	S1/S1	(1 / 1 - 1/255)
				CH2	C	S2/S2	(1 / 1 - 1/255)
4	8	C	8	CH1	S	A1/B1	(1 / 4 - 1/1020)
				CH2	C	A2/B2	(1 / 4 - 1/1020)
4	9	C	9	CH1	S	A1/B1	(1 / 2 - 1/510)
				CH2	C	A2/B2	(1 / 2 - 1/510)
4	A	C	A	CH1	S	A1/B1	(1 / 4 - 1/1020)
				CH2	C	S2/S2	(1 / 2 - 1/510)
4	B	C	B	CH1	S	A1/B1	(1 / 2 - 1/510)
				CH2	C	S2/S2	(1 / 1 - 1/255)
4	C	C	C	CH1	S	S1/S1	(1 / 2 - 1/510)
				CH2	C	A2/B2	(1 / 4 - 1/1020)
4	D	C	D	CH1	S	S1/S1	(1 / 1 - 1/255)
				CH2	C	A2/B2	(1 / 2 - 1/510)
4	E	C	E	CH1	S	S1/S1	(1 / 2 - 1/510)
				CH2	C	S2/S2	(1 / 2 - 1/510)
4	F	C	F	CH1	S	S1/S1	(1 / 1 - 1/255)
				CH2	C	S2/S2	(1 / 1 - 1/255)

A blank (-) is an undefined. An input and an output are unfixed.

Set point				CH	Input Pulse	Output Pulse	Division ratio setting Possible range
Open collector		Line receiver					
SW6	SW5	SW6	SW5				
5	0	D	0	CH1	S	A1/B1	(1 / 4 - 1/1020)
				CH2	C	A2/B2	(1 / 4 - 1/1020)
5	1	D	1	CH1	S	A1/B1	(1 / 2 - 1/510)
				CH2	C	A2/B2	(1 / 2 - 1/510)
5	2	D	2	CH1	S	A1/B1	(1 / 4 - 1/1020)
				CH2	C	S2/C2	(1 / 2 - 1/510)
5	3	D	3	CH1	S	A1/B1	(1 / 2 - 1/510)
				CH2	C	S2/C2	(1 / 1 - 1/255)
5	4	D	4	CH1	S	S1/C1	(1 / 2 - 1/510)
				CH2	C	A2/B2	(1 / 4 - 1/1020)
5	5	D	5	CH1	S	S1/C1	(1 / 1 - 1/255)
				CH2	C	A2/B2	(1 / 2 - 1/510)
5	6	D	6	CH1	S	S1/C1	(1 / 2 - 1/510)
				CH2	C	S2/C2	(1 / 2 - 1/510)
5	7	D	7	CH1	S	S1/C1	(1 / 1 - 1/255)
				CH2	C	S2/C2	(1 / 1 - 1/255)
5	8	D	8	CH1	S	CW1/CCW1	(1 / 2 - 1/510)
				CH2	C	S2/C2	(1 / 2 - 1/510)
5	9	D	9	CH1	S	CW1/CCW1	(1 / 1 - 1/255)
				CH2	C	S2/C2	(1 / 1 - 1/255)
5	A	D	A	CH1	S	S1/C1	(1 / 2 - 1/510)
				CH2	C	CW2/CCW2	(1 / 2 - 1/510)
5	B	D	B	CH1	S	S1/C1	(1 / 1 - 1/255)
				CH2	C	CW2/CCW2	(1 / 1 - 1/255)
5	C	D	C	CH1	S	CW1/CCW1	(1 / 2 - 1/510)
				CH2	C	CW2/CCW2	(1 / 2 - 1/510)
5	D	D	D	CH1	S	CW1/CCW1	(1 / 1 - 1/255)
				CH2	C	CW2/CCW2	(1 / 1 - 1/255)
5	E	D	E	CH1	-	-	-
				CH2	-	-	-
5	F	D	F	CH1	-	-	-
				CH2	-	-	-

A blank (-) is an undefined. An input and an output are unfixed.



## 4.2.5. (CW/CCW Input) setting list

Set point				CH	Input Pulse	Output Pulse	Division ratio setting Possible range
Open collector		Line receiver					
SW6	SW5	SW6	SW5				
6	0	E	0	CH1	CW	A1/B1	(1 / 4 - 1/1020)
				CH2	CCW	A2/B2	(1 / 4 - 1/1020)
6	1	E	1	CH1	CW	A1/B1	(1 / 2 - 1/510)
				CH2	CCW	A2/B2	(1 / 2 - 1/510)
6	2	E	2	CH1	CW	A1/B1	(1 / 4 - 1/1020)
				CH2	CCW	S2/S2	(1 / 2 - 1/510)
6	3	E	3	CH1	CW	A1/B1	(1 / 2 - 1/510)
				CH2	CCW	S2/S2	(1 / 1 - 1/255)
6	4	E	4	CH1	CW	S1/S1	(1 / 2 - 1/510)
				CH2	CCW	A2/B2	(1 / 4 - 1/1020)
6	5	E	5	CH1	CW	S1/S1	(1 / 1 - 1/255)
				CH2	CCW	A2/B2	(1 / 2 - 1/510)
6	6	E	6	CH1	CW	S1/S1	(1 / 2 - 1/510)
				CH2	CCW	S2/S2	(1 / 2 - 1/510)
6	7	E	7	CH1	CW	S1/S1	(1 / 1 - 1/255)
				CH2	CCW	S2/S2	(1 / 1 - 1/255)
6	8	E	8	CH1	CW	A1/B1	(1 / 4 - 1/1020)
				CH2	CCW	A2/B2	(1 / 4 - 1/1020)
6	9	E	9	CH1	CW	A1/B1	(1 / 2 - 1/510)
				CH2	CCW	A2/B2	(1 / 2 - 1/510)
6	A	E	A	CH1	CW	A1/B1	(1 / 4 - 1/1020)
				CH2	CCW	S2/S2	(1 / 2 - 1/510)
6	B	E	B	CH1	CW	A1/B1	(1 / 2 - 1/510)
				CH2	CCW	S2/S2	(1 / 1 - 1/255)
6	C	E	C	CH1	CW	S1/S1	(1 / 2 - 1/510)
				CH2	CCW	A2/B2	(1 / 4 - 1/1020)
6	D	E	D	CH1	CW	S1/S1	(1 / 1 - 1/255)
				CH2	CCW	A2/B2	(1 / 2 - 1/510)
6	E	E	E	CH1	CW	S1/S1	(1 / 2 - 1/510)
				CH2	CCW	S2/S2	(1 / 2 - 1/510)
6	F	E	F	CH1	CW	S1/S1	(1 / 1 - 1/255)
				CH2	CCW	S2/S2	(1 / 1 - 1/255)

A blank (-) is an undefined. An input and an output are unfixed

Set point				CH	Input Pulse	Output Pulse	Division ratio setting Possible range
Open collector		Line receiver					
SW6	SW5	SW6	SW5				
7	0	F	0	CH1	CW	A1/B1	(1 / 4 - 1/1020)
				CH2	CCW	A2/B2	(1 / 4 - 1/1020)
7	1	F	1	CH1	CW	A1/B1	(1 / 2 - 1/510)
				CH2	CCW	A2/B2	(1 / 2 - 1/510)
7	2	F	2	CH1	CW	A1/B1	(1 / 4 - 1/1020)
				CH2	CCW	S2/C2	(1 / 2 - 1/510)
7	3	F	3	CH1	CW	A1/B1	(1 / 2 - 1/510)
				CH2	CCW	S2/C2	(1 / 1 - 1/255)
7	4	F	4	CH1	CW	S1/C1	(1 / 2 - 1/510)
				CH2	CCW	A2/B2	(1 / 4 - 1/1020)
7	5	F	5	CH1	CW	S1/C1	(1 / 1 - 1/255)
				CH2	CCW	A2/B2	(1 / 2 - 1/510)
7	6	F	6	CH1	CW	S1/C1	(1 / 2 - 1/510)
				CH2	CCW	S2/C2	(1 / 2 - 1/510)
7	7	F	7	CH1	CW	S1/C1	(1 / 1 - 1/255)
				CH2	CCW	S2/C2	(1 / 1 - 1/255)
7	8	F	8	CH1	CW	CW1/CCW1	(1 / 2 - 1/510)
				CH2	CCW	S2/C2	(1 / 2 - 1/510)
7	9	F	9	CH1	CW	CW1/CCW1	(1 / 1 - 1/255)
				CH2	CCW	S2/C2	(1 / 1 - 1/255)
7	A	F	A	CH1	CW	S1/C1	(1 / 2 - 1/510)
				CH2	CCW	CW2/CCW2	(1 / 2 - 1/510)
7	B	F	B	CH1	CW	S1/C1	(1 / 1 - 1/255)
				CH2	CCW	CW2/CCW2	(1 / 1 - 1/255)
7	C	F	C	CH1	CW	CW1/CCW1	(1 / 2 - 1/510)
				CH2	CCW	CW2/CCW2	(1 / 2 - 1/510)
7	D	F	D	CH1	-	-	-
				CH2	-	-	-
7	E	F	E	CH1	-	-	-
				CH2	-	-	-
7	F	F	F	CH1	-	-	-
				CH2	-	-	-

A blank (-) is an undefined. An input and an output are unfixed.

(Example 1) When Setting the Rotary DIP switch set value of operational mode as "00".

Input form	Current drive input by photo coupler insulation
Input terminal	CH1
Input pulse	Single phase pulse
Input terminal	CH2
Input pulse	Nothing
Output terminal	CH1
Output pulse (1)	A phase pulse
Output pulse (2)	B phase pulse
Setting of the division ratio	RSW2, RSW1 (1/4 - 1/1020)
Output terminal	CH2
Output pulse (3)	A phase pulse
Output pulse (4)	B phase pulse
Setting of the division ratio	RSW4, RSW3 (1/4 - 1/1020)

(Example 2) When Setting the Rotary DIP switch set value of operational mode as "85".

Input form	Line receiver input
Input terminal	CH1
Input pulse	Single phase pulse
Input terminal	CH2
Input pulse	Nothing
Output terminal	CH1
Output pulse (1)	Single phase pulse
Output pulse (2)	Single phase pulse
Setting of a division ratio	RSW2, RSW1 (1/1 - 1/255)
Output terminal	CH2
Output pulse (3)	A phase pulse
Output pulse (4)	B phase pulse
Setting of a division ratio	RSW4, RSW3 (1/2 - 1/510)

### 4.3. Block diagram

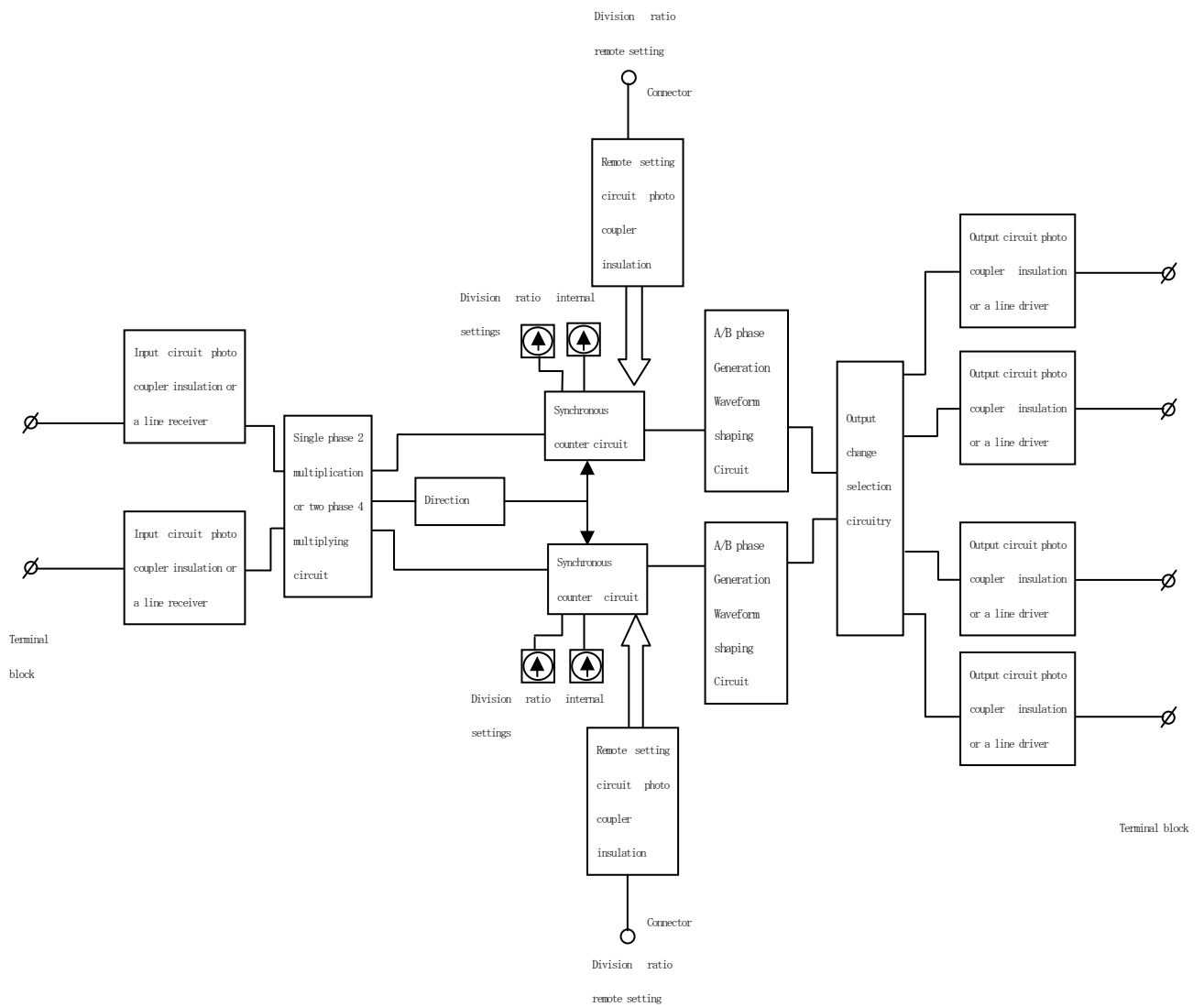

## 5. Input output circuit

### 5.0. Connection Conversion Table

	Rotary encoder Output circuit form	Double Wave Modulation Unit Connection propriety	Notes
Voltage output (Collector output)		If it is what fulfills the conditions of notes, It is connectable by current drive input connection.	The maximum output inflow electric current by the side of a rotary encoder is checked, and if it is in tolerance, it can input.  Since the logic of a rotary encoder is reverse, there is delay of the phase angle of a half cycle.
Voltage output (Emitter) Follower output		It is not connectable.	
Open collector Output		It is connectable by current drive input connection.	
Voltage output (Totem pole) Output		If it is what fulfills the conditions of notes, It is connectable by current drive input connection.	The maximum output inflow electric current by the side of a rotary encoder is checked, and if it is in tolerance, it can input.  Since the logic of a rotary encoder is reverse, there is delay of the phase angle of a half cycle.
Voltage output (Complimentary) Output		If it is what fulfills the conditions of notes, It is connectable by current drive input connection.	The maximum output inflow electric current by the side of a rotary encoder is checked, and if it is in tolerance, it can input.  Since the logic of a rotary encoder is reverse, there is delay of the phase angle of a half cycle.
Line driver Output		It is connectable to line receiver input connection,	

### 5.1. Current Drive Input Circuit by Photo Coupler Insulation

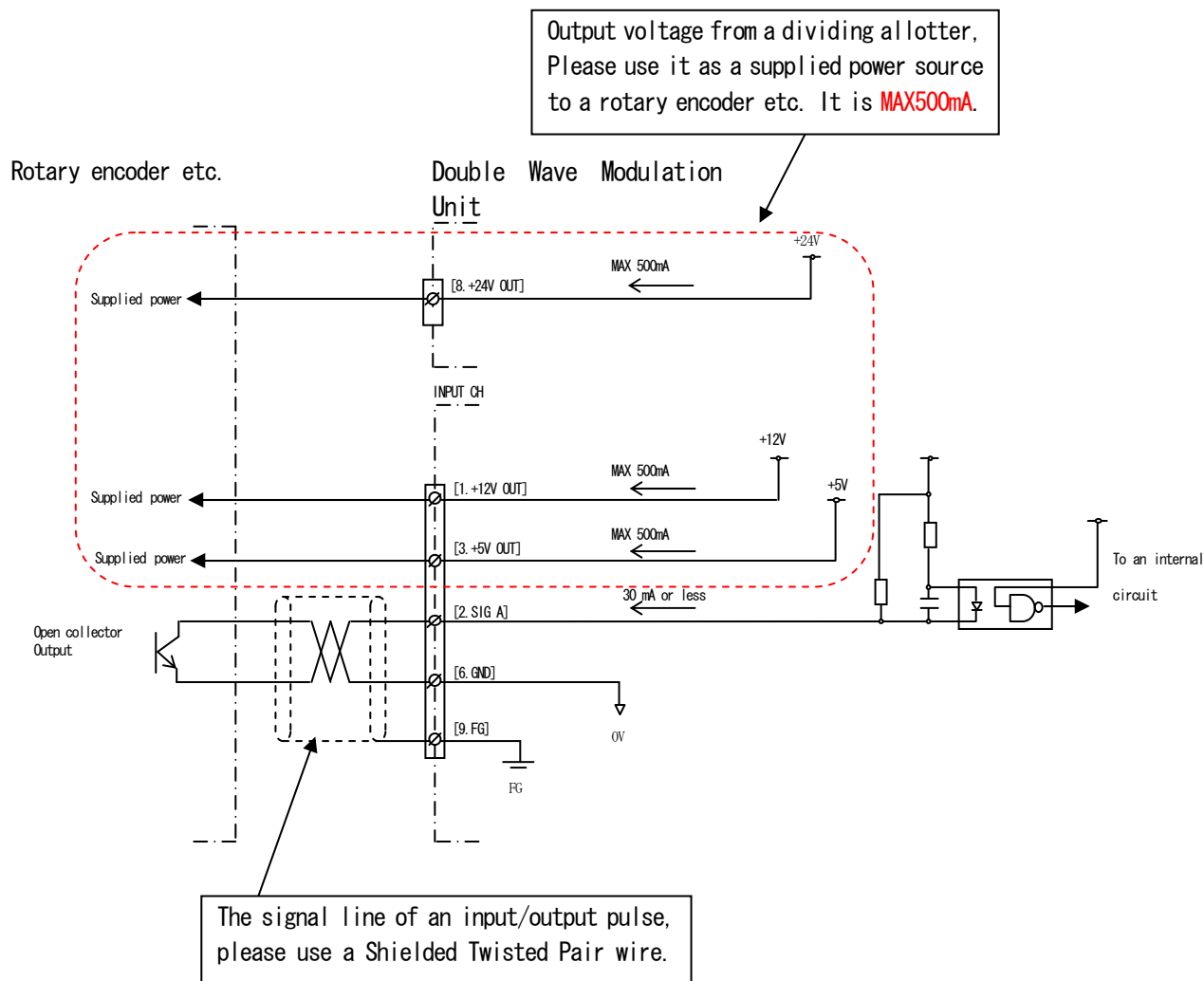

## 5.2. Line Receiver Input Circuit

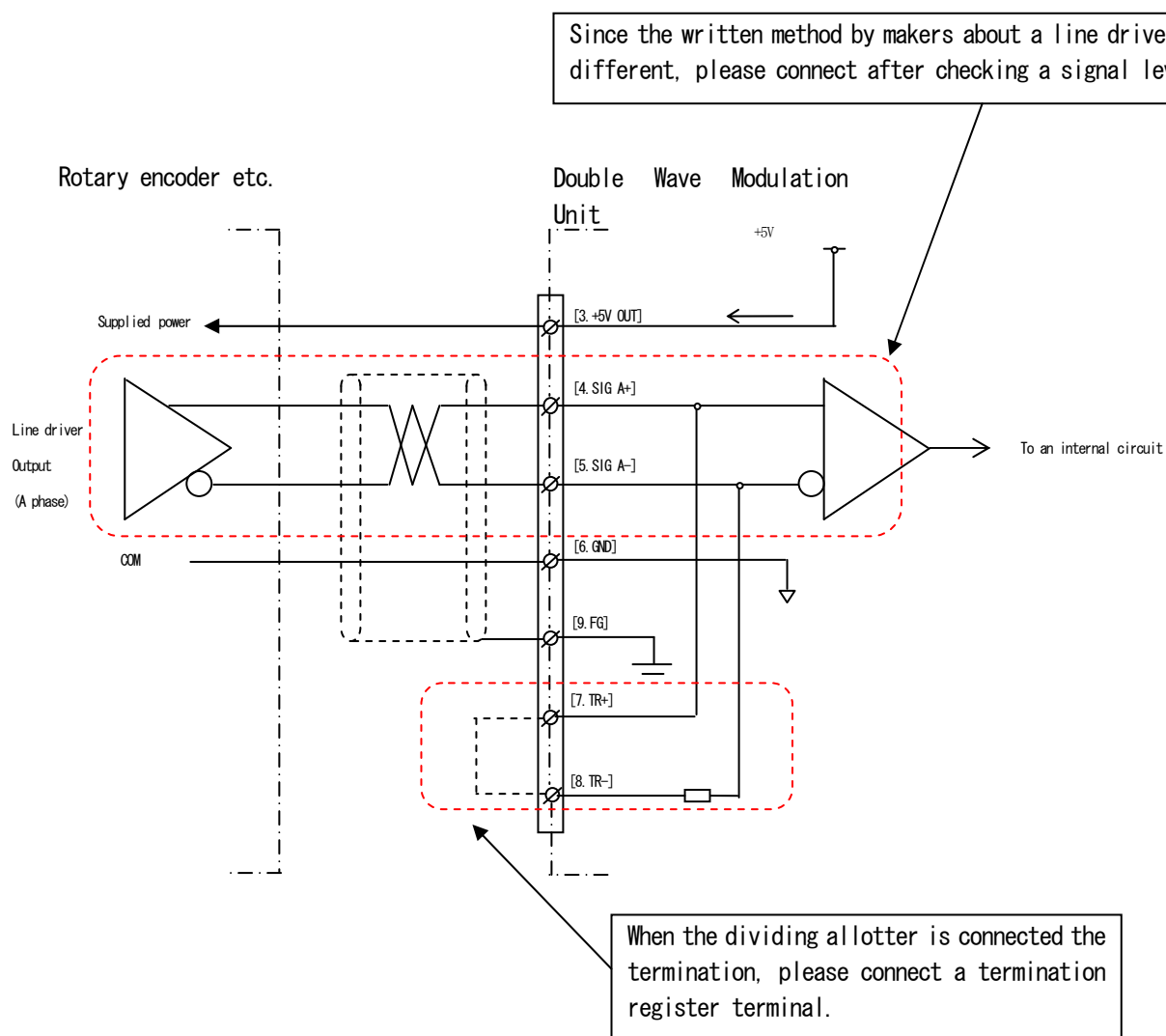

### 5.3. Open Collector Output Circuit by Photo Coupler Insulation

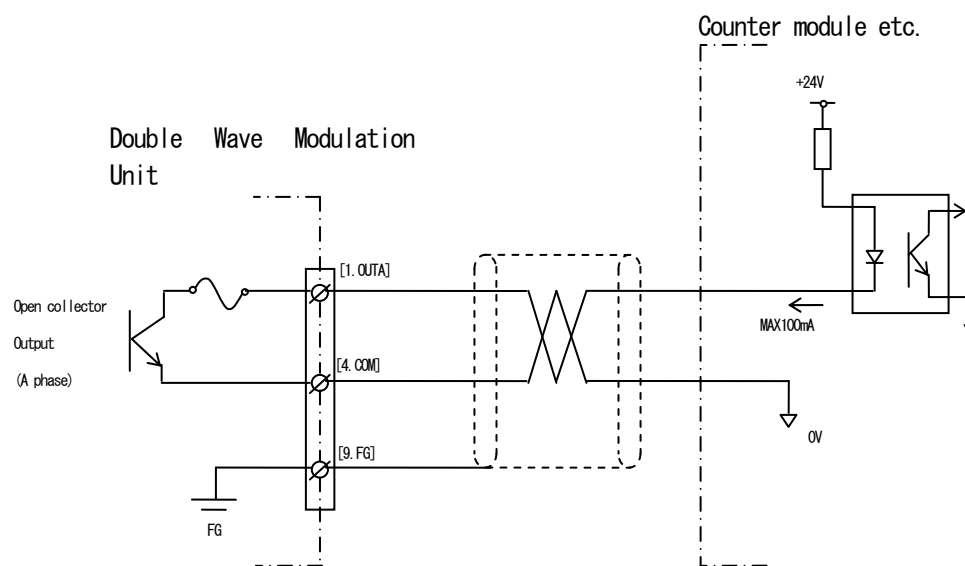



### 5.4. Line Driver Output Circuit

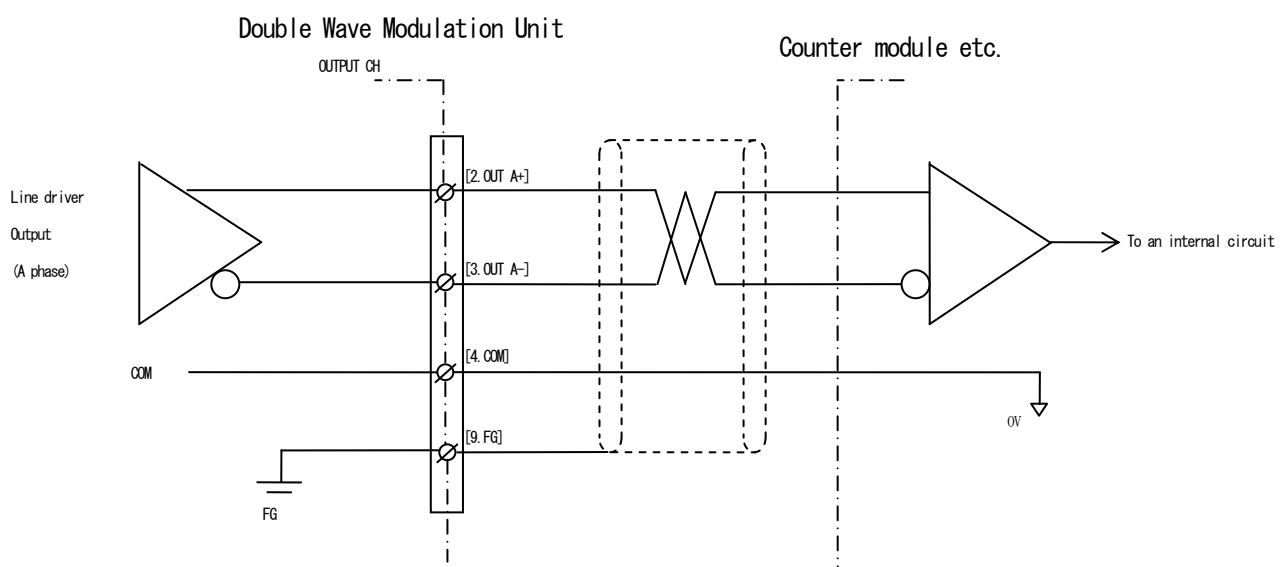

### 5.5. Remote Input Circuit

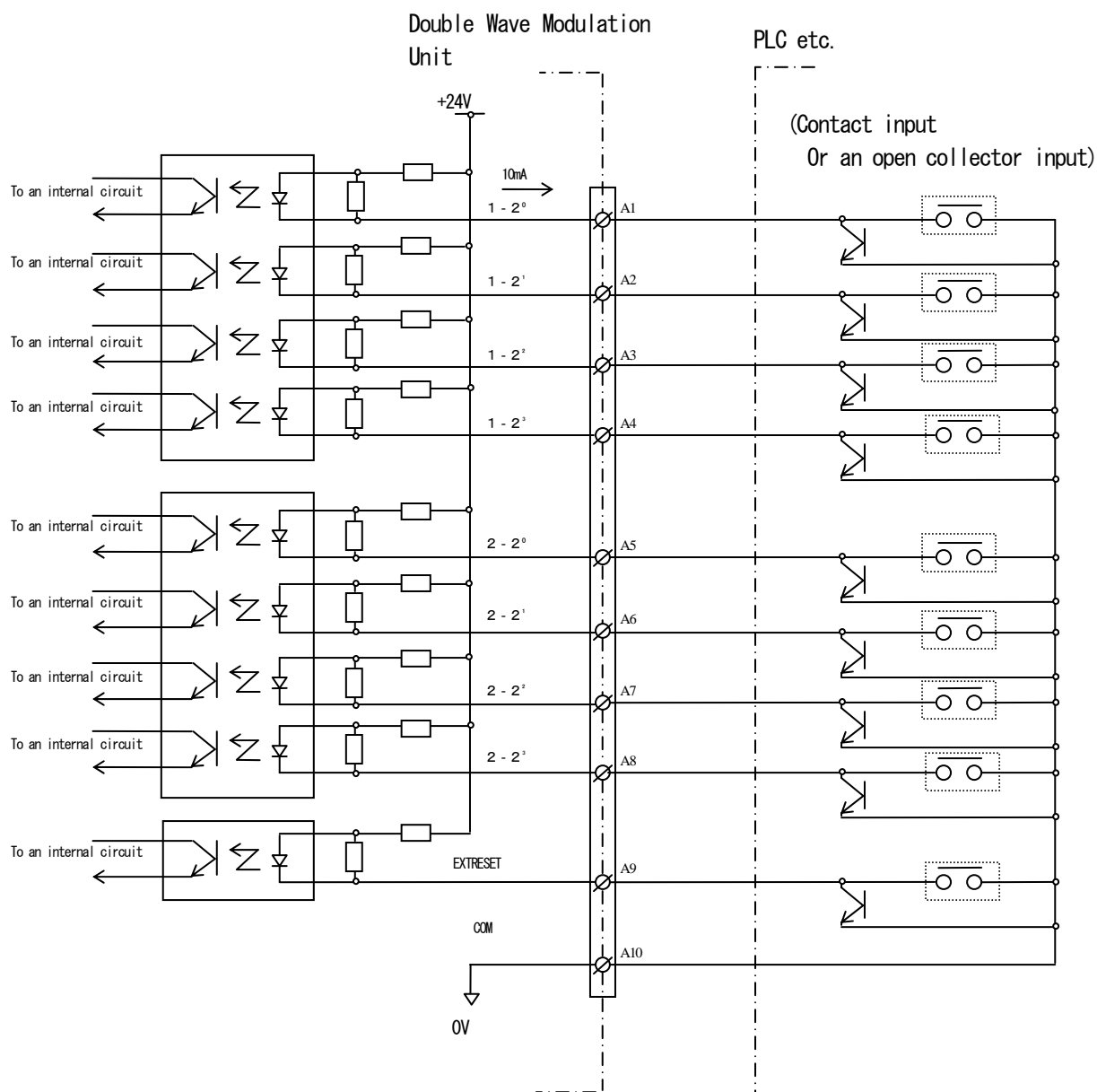

6. Outline drawing

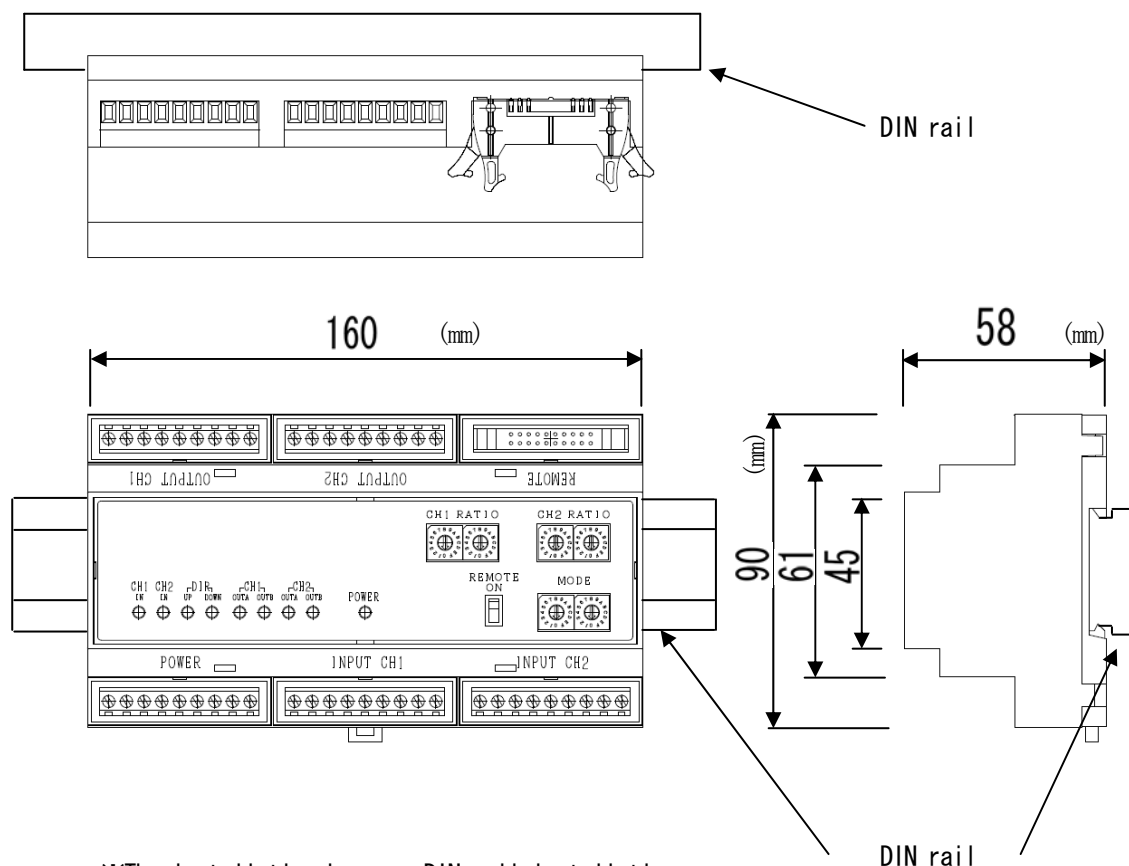

※The installation becomes DIN rail installation.

## 7. Timing chart

(The timing chart is described by negative logic.)

### (1) Single phase pulse input - single phase pulse output

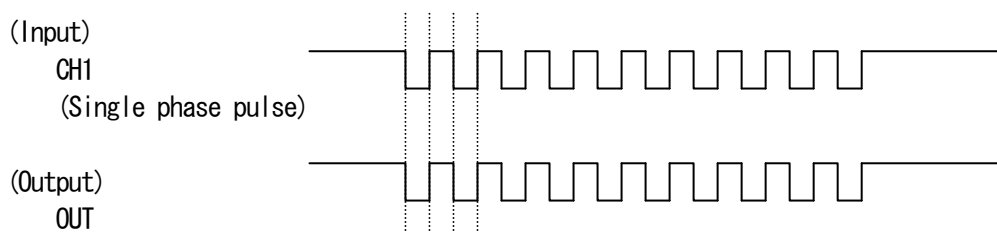

### (2) Single phase pulse input - two phase pulse output

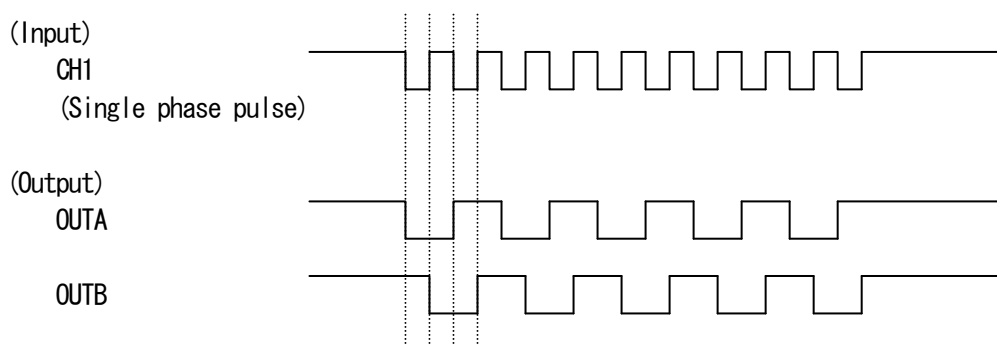

### (3) Two phase pulse input - single phase pulse output

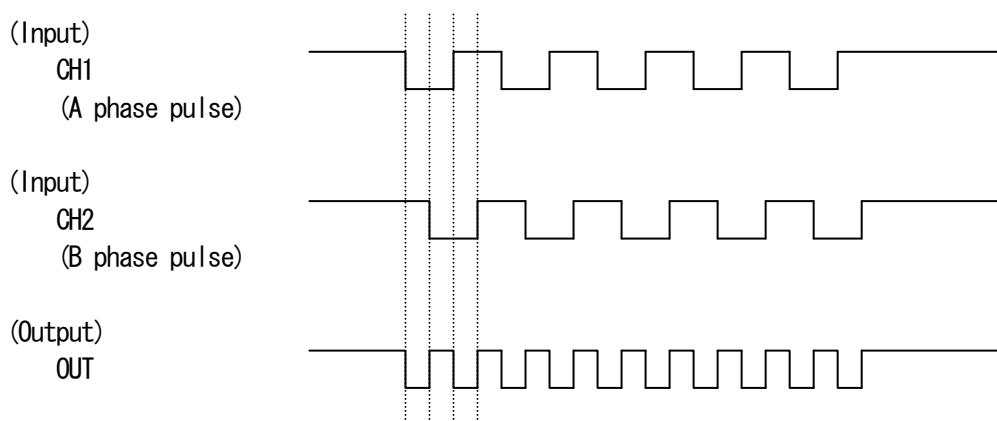

(4) Two phase pulse input - two phase pulse output

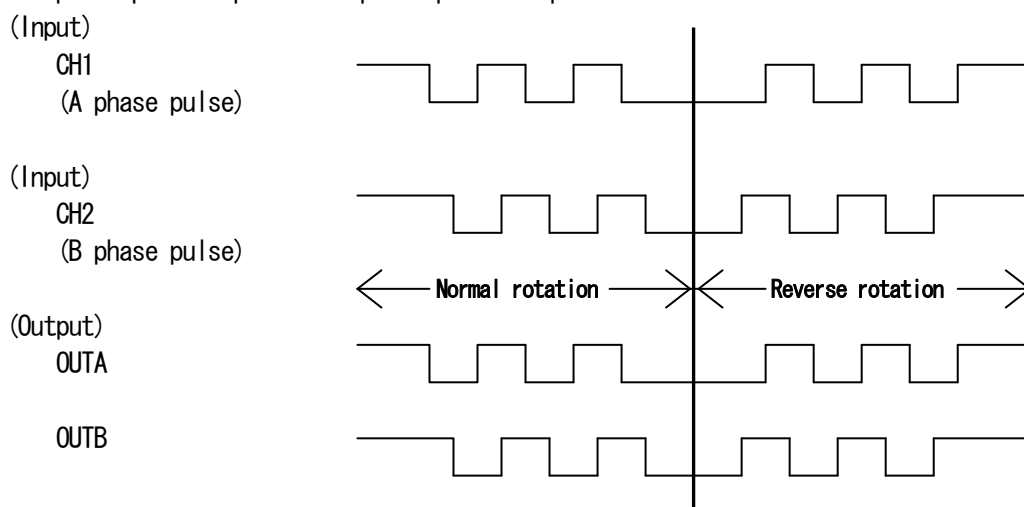

(5) Two phase pulse input - single phase pulse output with direction-discriminating-signal

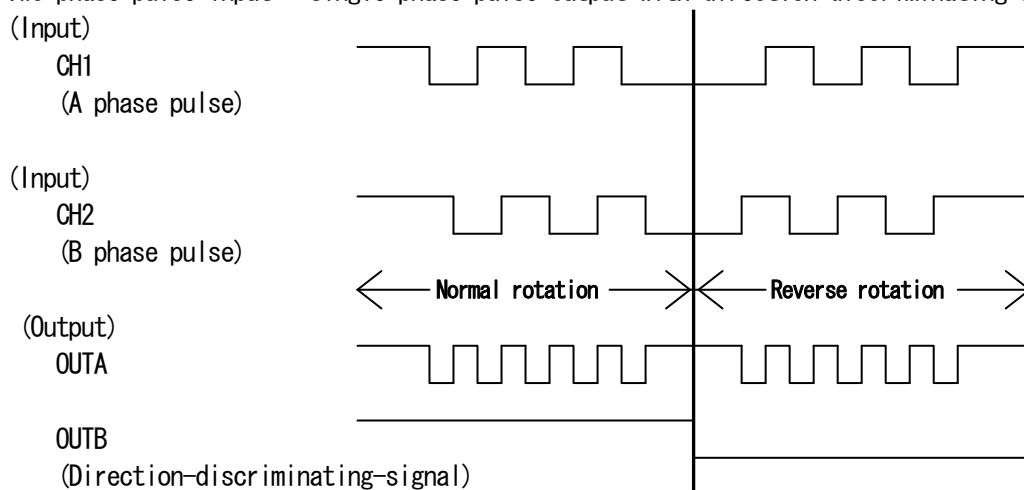

(6) Two phase pulse input - CW-CCW pulse output

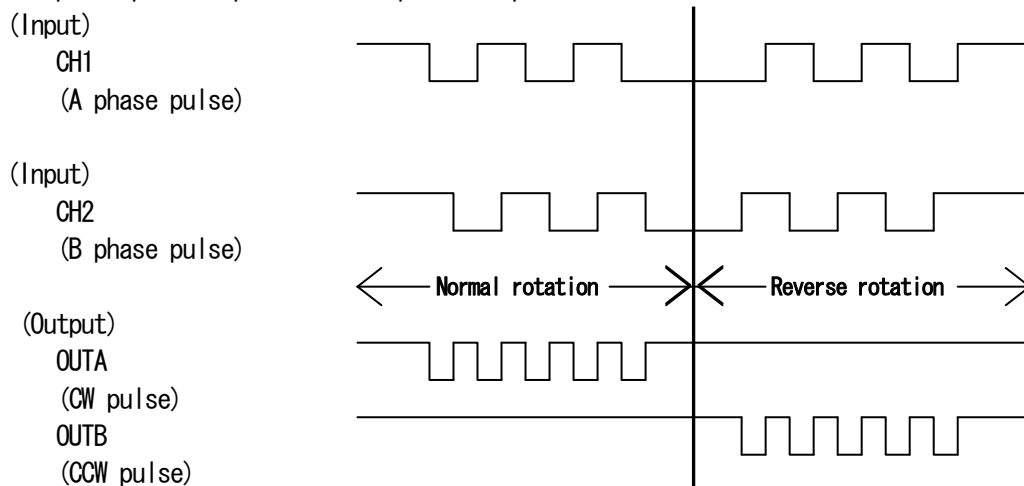

(7) Single phase pulse with direction-discriminating-signal input - single phase pulse output

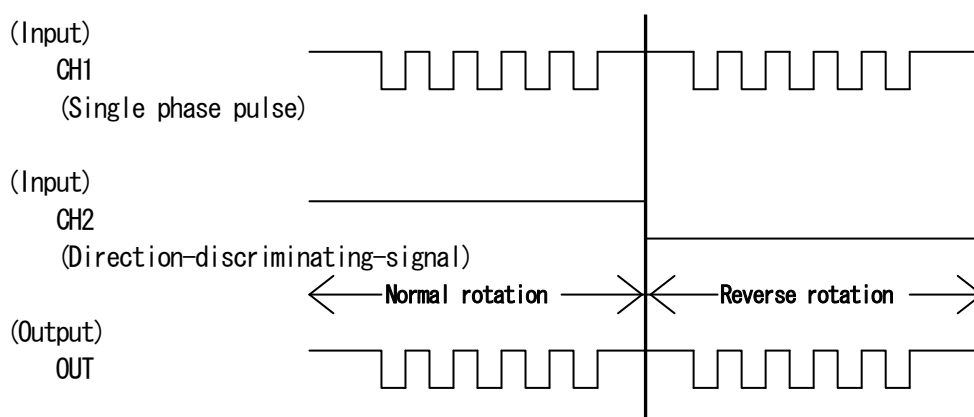

(8) Single phase pulse with direction-discriminating-signal input - two phase pulse output

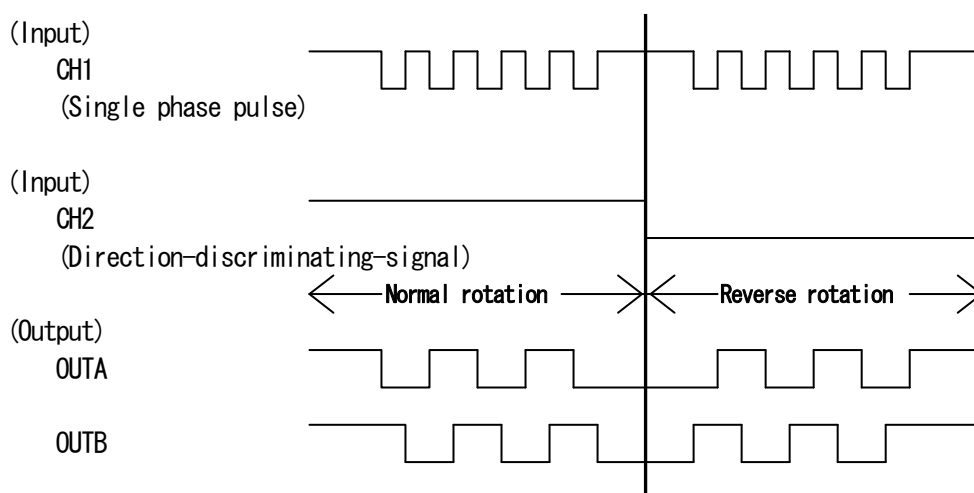

(9) Single phase pulse with direction-discriminating-signal input - single phase pulse with input-direction-discriminating-signal output

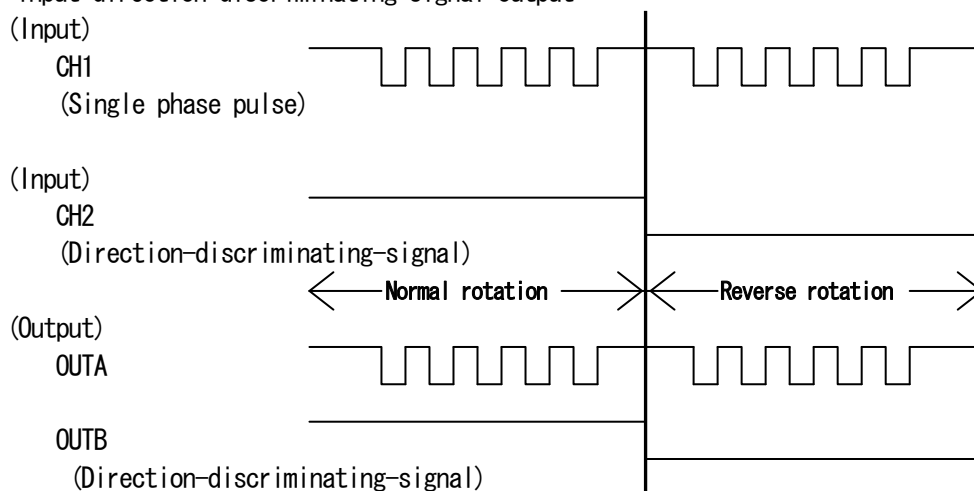

(10) Single phase pulse with direction-discriminating-signal input - CW-CCW pulse output

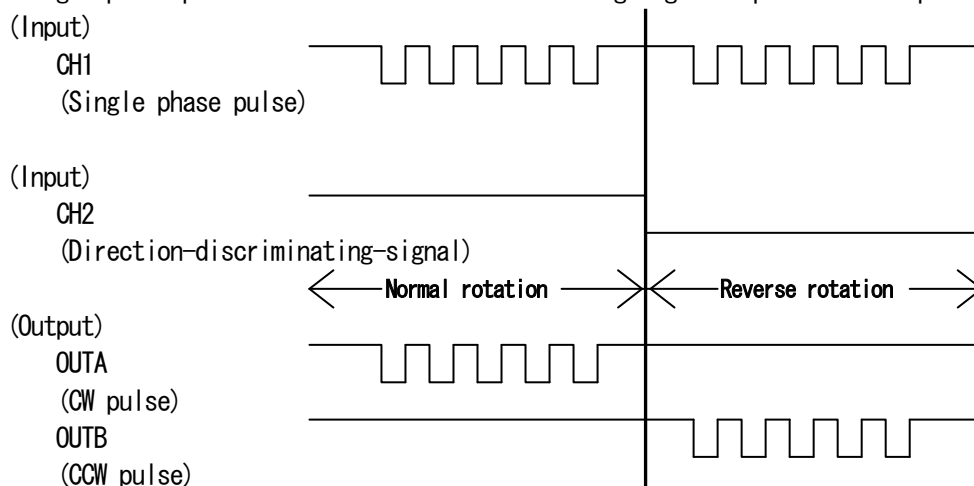

(11) CW-CCW pulse input - two phase pulse output

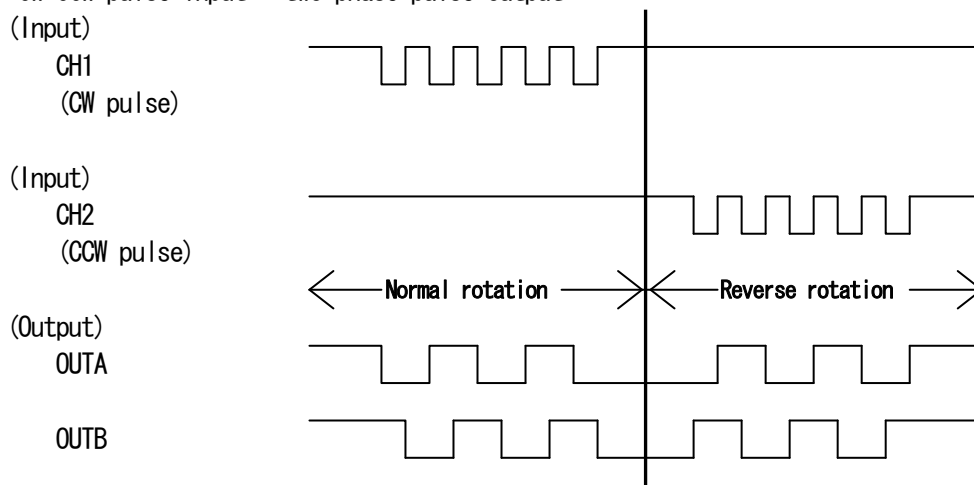

(12) CW-CCW pulse input - single phase pulse with direction-discriminating-signal output

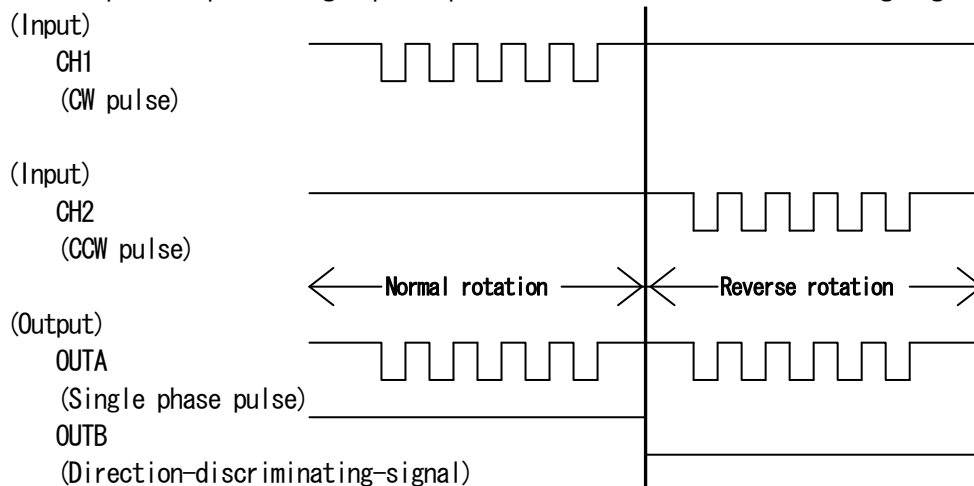

(13) CW-CCW pulse input - CW-CCW pulse output

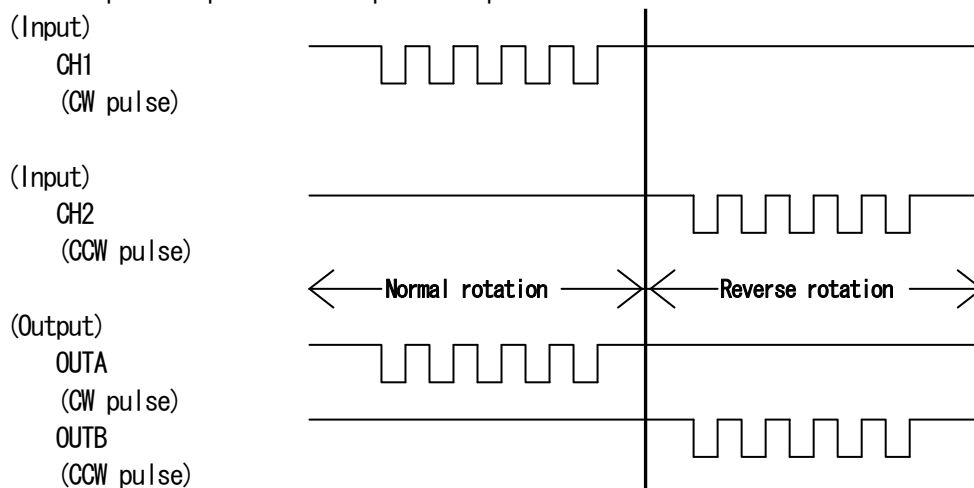

■ At the time of 1/2 dividing

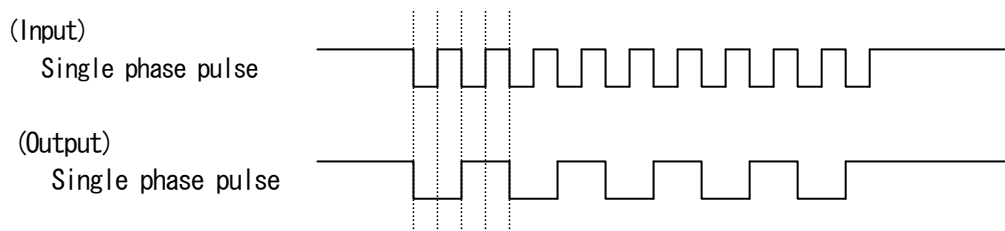

■ At the time of 1/3 dividing

